

HORIZON HIGH BACK ROCKER

HZ-0300

BREEZESTA *tm*
Recycled Poly Furniture

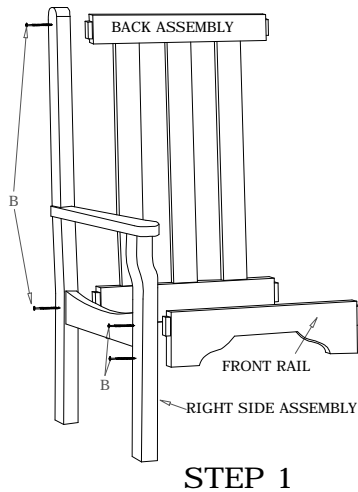

STEP 1

Attach Back Assembly and Front Rail to Right Side Assembly using screws (B) as shown.

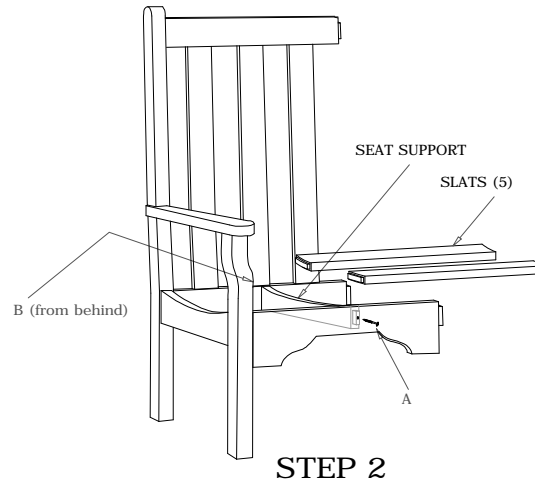

STEP 2

Attach Seat Support using a screw (A) in the front and screw (B) in the back. Install Slats into slots provided on Right Side Assembly.

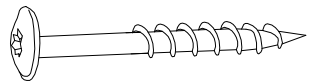

A-1.5" (7 pcs.) colored

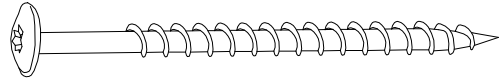

B-2.5" (9 pcs.) colored

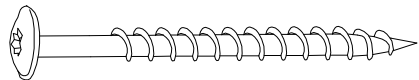

C-2" (5 pcs.) uncolored

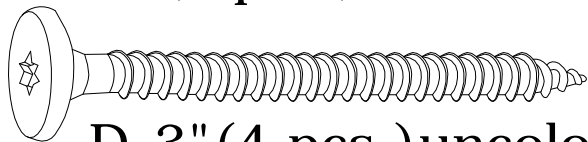

D-3" (4 pcs.) uncolored

LIST OF PARTS

- Back Assembly (1)
- Left End Assembly (1)
- Right End Assembly (1)
- Front Rail (1)
- Under Seat Supports (1)
- Seat Slats (5)
- Rockers (2)
- Colored Screws "A" (7)
- Colored Screws "B" (9)
- Un-Colored Screws "C" (5)
- Colored Screws "D" (4)
- Insert Bit Tool (1)

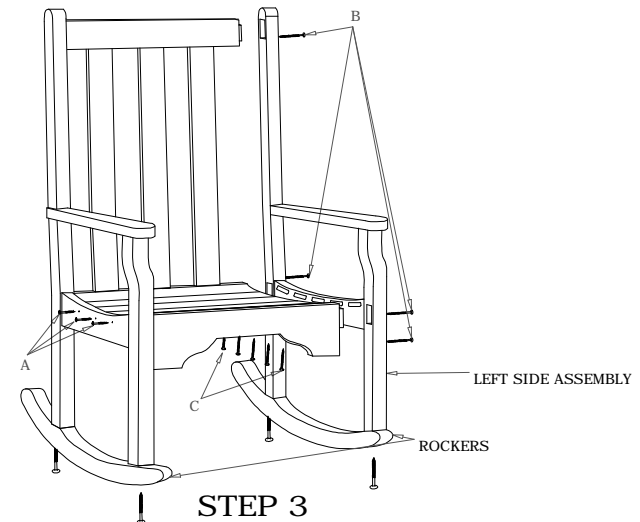

STEP 3

Attach Left Side Assembly as shown using screws (B). From the bottom side use uncolored screws (C) to secure slats. Use screws (A) to attach Side Assemblies to Slats. Attach Rocker to bottom with screws (D).